

DUAL PLATECHECK VALVE ANSI 300 - 31598

No	Part	Material
1	Body	ASTM B351 - CF8M
2	Plate	ASTM B351 - CF8M
3	Seat	NBR
4	Stop pin	AISI 316
5	Hinge pin	AISI 316
6	Spring	Inconel X-750
7	Bearing	PTFE
8	Plug	AISI 316
9		
10		

Variants:
Seat in EPDM or Viton

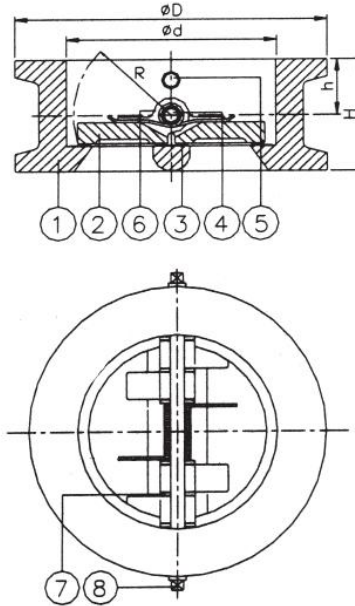

Other dimensions/materials on request

DN	D	d	H	R radius	Max working-pressure Mpa		Weight Kg
					-29 to 38 °C	149 °C	
50	111	60	60	27	5,1	4,51	
65	130	73	67	33	5,1	4,51	
80	149	89	73	41	5,1	4,51	
100	181	114	73	54	5,1	4,51	
125	216	141	86	65	5,1	4,51	
150	251	168	98	79	5,1	4,51	
200	308	219	127	102	5,1	4,51	
250	362	273	146	126	5,1	4,51	
300	422	324	181	152	5,1	4,51	