

SAFETY VALVE PN16 - 473795

No	Part	Material
1	Body	Bronze Rg5
2	Bonnet	Bronze Rg5
3	Spring	Stainless steel SS316
4	Stem	Special brass
5	Nut	Special brass
6	Locking nut	Special brass
7	Disc	Bronze Rg5

Variants:

Flanged end

Other dimensions/materials on request

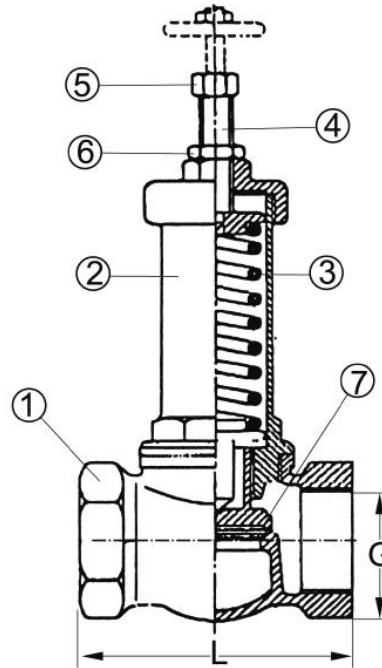

DN	G	L	Max working-pressure		Weight Kg
			Mpa		
15	1/2"	62	1,3		0,7
20	3/4"	70	1,3		0,9
25	1"	84	1,3		1,3
32	1 1/4"	105	1,3		2,2
40	1 1/2"	120	1,3		3,1
50	2"	145	1,3		4,2
65	2 1/2"	200	1,3		9,4