

GATE VALVE PN25 620763

No	Part	Material
1	Body	Cast steel GSC25
2	Bonnet	Cast steel GSC25
3	Disc ring	Stainless steel X20Cr13
4	Seat ring	Stainless steel X20Cr13
5	Packing	Graphite
6	Stem (rising)	Stainless steel X20Cr13
7	Glandpacking	Graphite

Variants:
 With drain plug
 Various actuators
 Non rising stem
 Butt weld end
 Other dimensions/materials on request

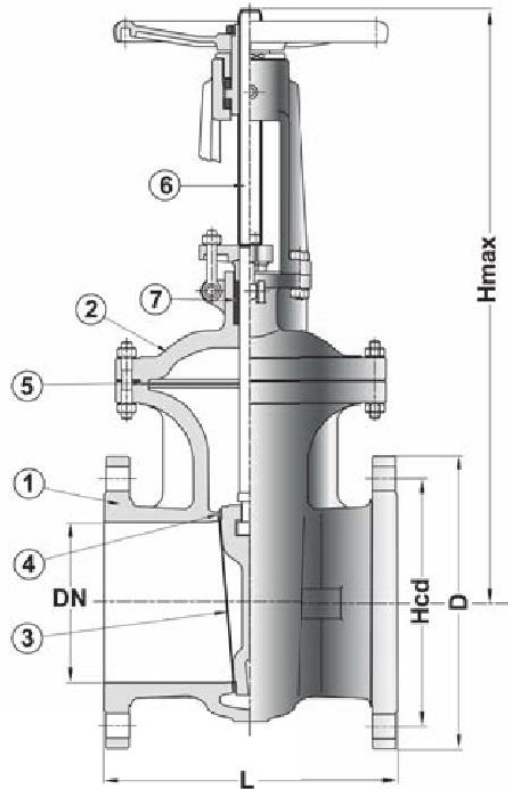

DN	D	n x Ød	Hcd	L	Hmax	Max working-pressure		Weight Kg
						Mpa 120 °C	Mpa 400 °C	
40	150	4x18	110	240	370	2,5	1,5	18,0
50	165	4x18	125	250	400	2,5	1,5	24,5
65	185	8x18	145	270	520	2,5	1,5	38,5
80	200	8x18	160	280	570	2,5	1,5	46,5
100	235	8x18	190	300	630	2,5	1,5	57,0
125	270	8x22	220	325	735	2,5	1,5	96,0
150	300	8x26	250	350	880	2,5	1,5	132,0
200	360	12x30	310	400	1040	2,5	1,5	175,0
250	425	12x33	370	450	1235	2,5	1,5	290,0
300	485	16x33	430	500	1390	2,5	1,5	386,0
350	555	16x33	490	550	1720	2,5	1,5	520,0
400	620	16x36	550	600	1980	2,5	1,5	680,0
500	730	20x36	660	700	2390	2,5	1,5	1060